

8 7 6 5 4 3 2 1

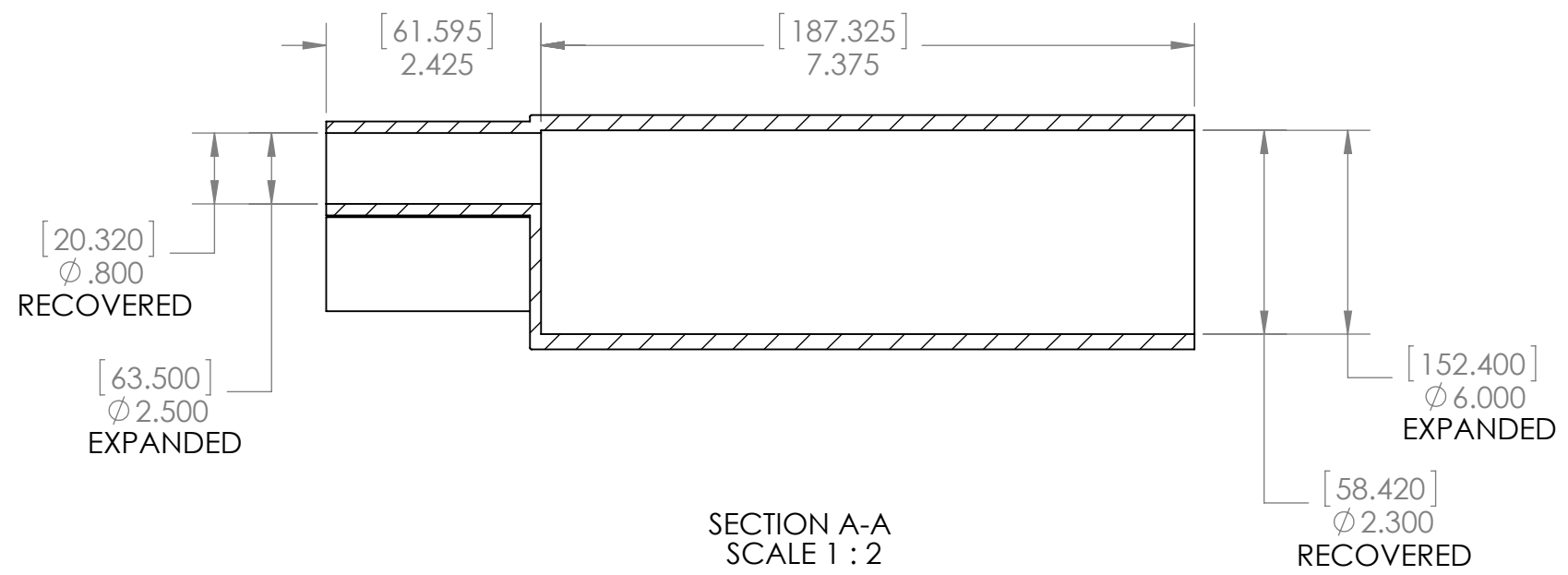
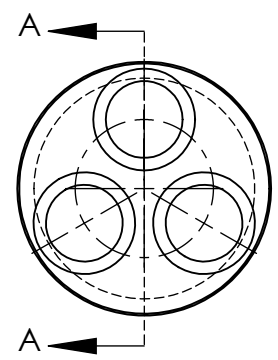
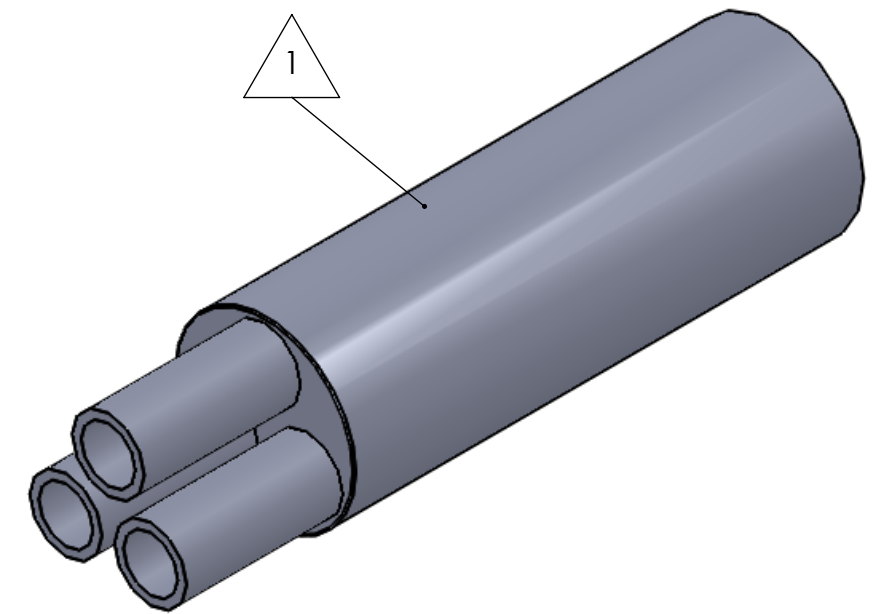

D
C
B
A

D
C
B
A

ITEM	PART DESCRIPTION	PART NO.	MATERIAL	Nu-Tech	
①	Heat-shrinkable boot		HS 3123		
				UNLESS OTHERWISE SPECIFIED: DIMENSIONS ARE IN INCHES TOLERANCES: FRACTIONAL ± 1/32 THREE PLACE DECIMAL ± 0.030	
				DWG. NO.	
⑤	Adhesive	A-010	Hotmelt ADH	DO NOT SCALE DRAWING	WEIGHT: 0.608 REV
				DRAWN: HH DATE: 9/29/2016	SCALE: 1:4 SHEET 1 OF 1

8 7 6 5 4 3 2 1