

8 7 6 5 4 3 2 1

D
C
B
A

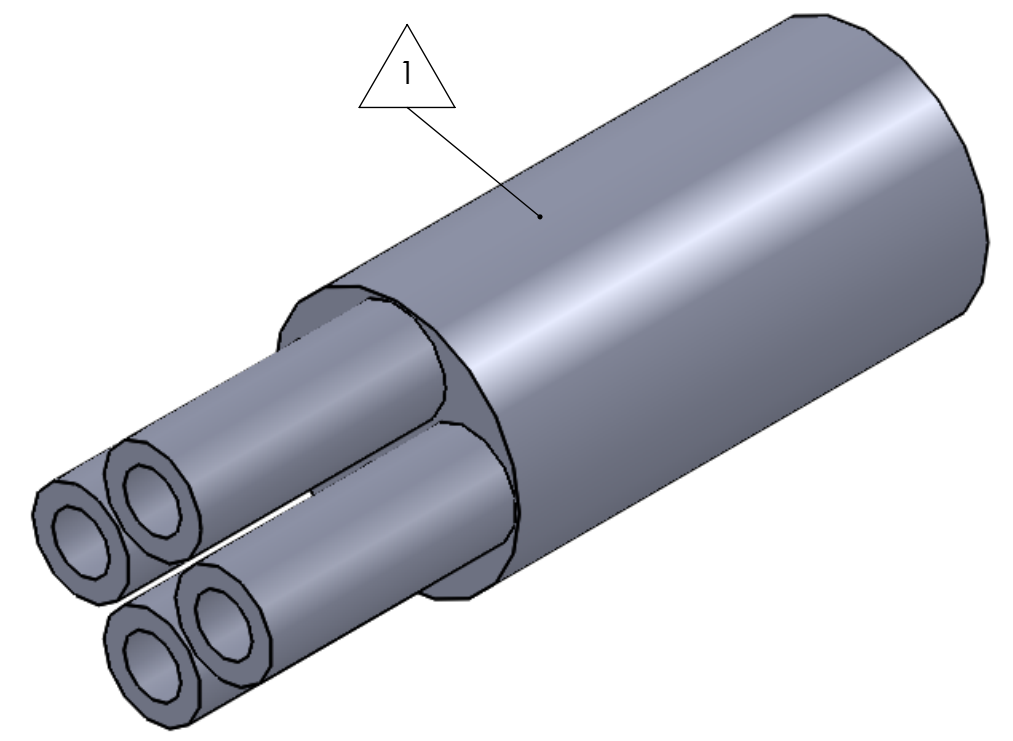
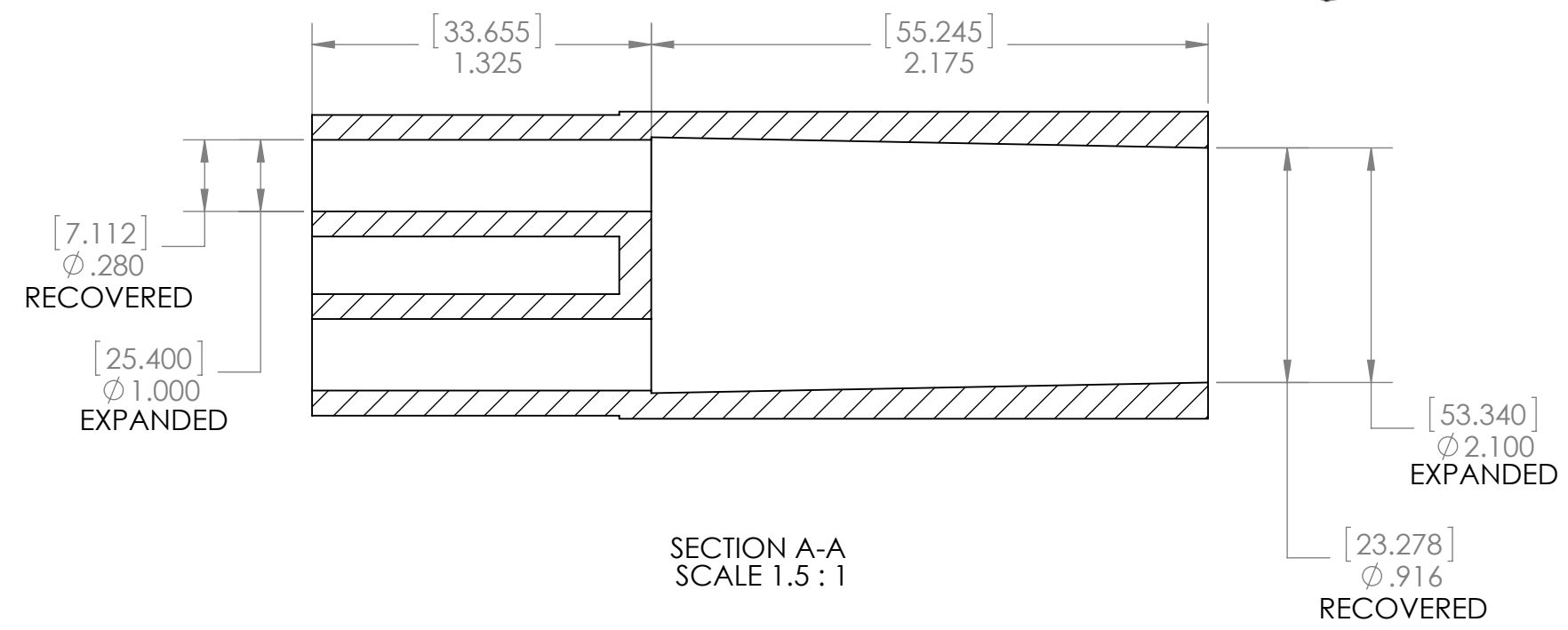
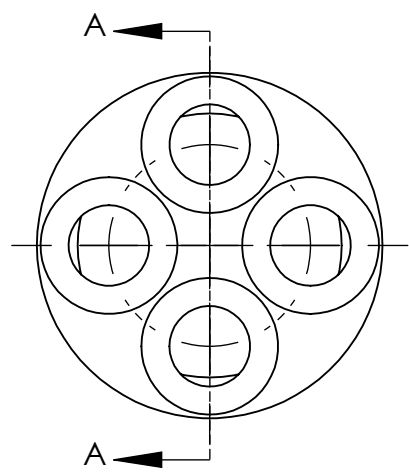

ITEM	PART DESCRIPTION	PART NO.	MATERIAL
①	Heat-shrinkable boot		HS 3123
⑤	Adhesive	A-010	Hotmelt ADH

Nu-Tech

UNLESS OTHERWISE SPECIFIED:
DIMENSIONS ARE IN INCHES
TOLERANCES:
FRACTIONAL ±1/32
THREE PLACE DECIMAL ± 0.030

DO NOT SCALE DRAWING

PART NO.		NUBB4-3	
DWG. NO.			
WEIGHT:	0.112	REV	
DRAWN: HH	DATE: 9/29/2016	SCALE: 1:1	SHEET 1 OF 1

8 7 6 5 4 3 2 1