

8 7 6 5 4 3 2 1

D
C
B
A

D
C
B
A

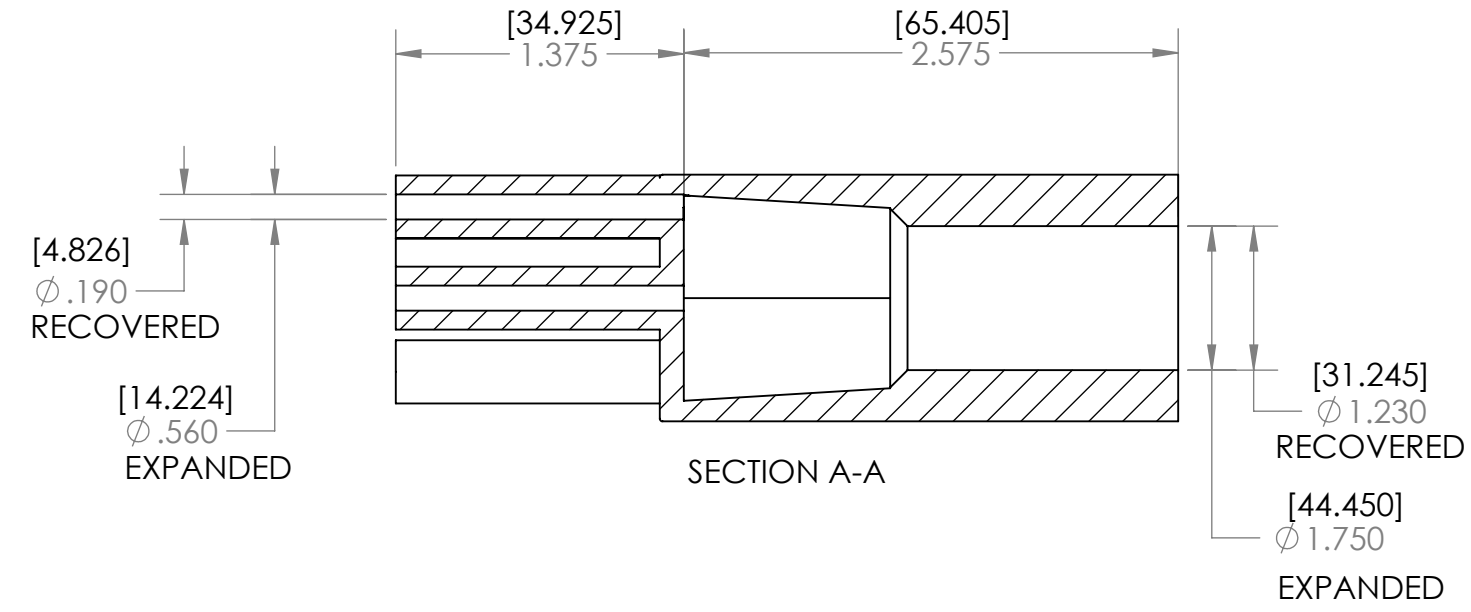
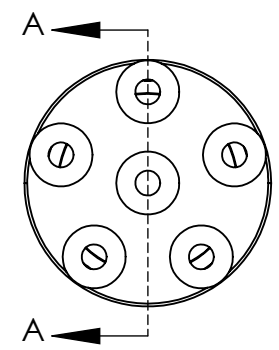
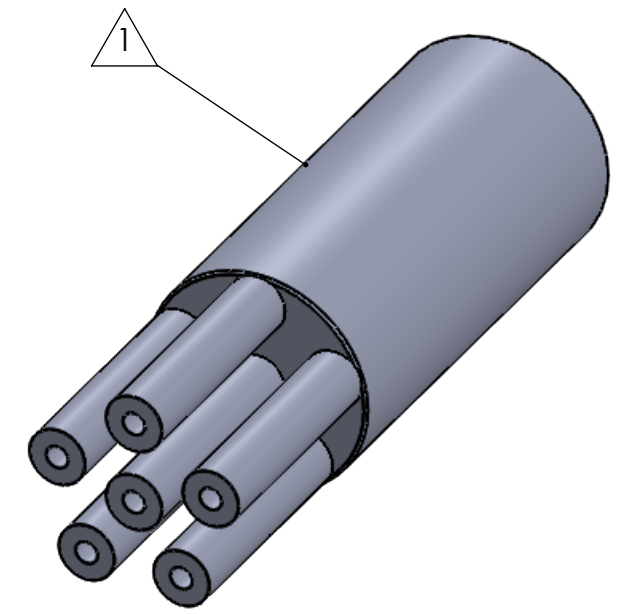

ITEM	PART DESCRIPTION	PART NO.	MATERIAL	Nu-Tech	
	Heat-shrinkable boot		HS 3123		
				UNLESS OTHERWISE SPECIFIED: DIMENSIONS ARE IN INCHES TOLERANCES: FRACTIONAL $\pm 1/32$ THREE PLACE DECIMAL ± 0.030	
	Adhesive	A-010	Hotmelt ADH	DO NOT SCALE DRAWING WEIGHT: 0.134 REV	
				DRAWN: HH DATE: 6/9/2021 SCALE: 1:1	SHEET 1 OF 1

8 7 6 5 4 3 2 1